

CURVE TABLE					
CURVE	RADIUS	ARC LENGTH	DELTA ANGLE	CHORD BEARING	CHORD LENGTH
C1	44.00'	13.98'	18°12'25"	N 09°56'08" W	13.92'
C2	650.00'	159.98'	14°06'07"	N 83°53'12" W	159.58'
C3	30.00'	20.26'	38°41'10"	N 18°30'41" E	19.87'
C4	20.00'	6.37'	18°14'51"	N 09°57'20" W	6.34'
C5	25.00'	39.27'	90°00'00"	S 45°55'00" E	35.36'
C6	19.88'	29.92'	86°14'03"	N 46°05'59" E	27.18'
C7	20.00'	28.98'	83°00'40"	N 49°24'40" W	26.51'
C8	49.00'	76.97'	90°00'00"	N 45°55'00" W	69.30'
C9	55.24'	26.99'	27°59'22"	S 12°12'55" E	26.72'
C10	28.37'	10.31'	20°48'55"	S 12°11'13" W	10.25'
C11	34.41'	12.43'	20°42'23"	S 12°14'29" W	12.37'
C12	102.47'	25.79'	14°25'08"	S 04°14'41" E	25.72'
C13	81.64'	37.35'	26°12'56"	S 01°39'13" W	37.03'
C14	57.34'	15.88'	15°52'04"	S 06°49'39" W	15.83'

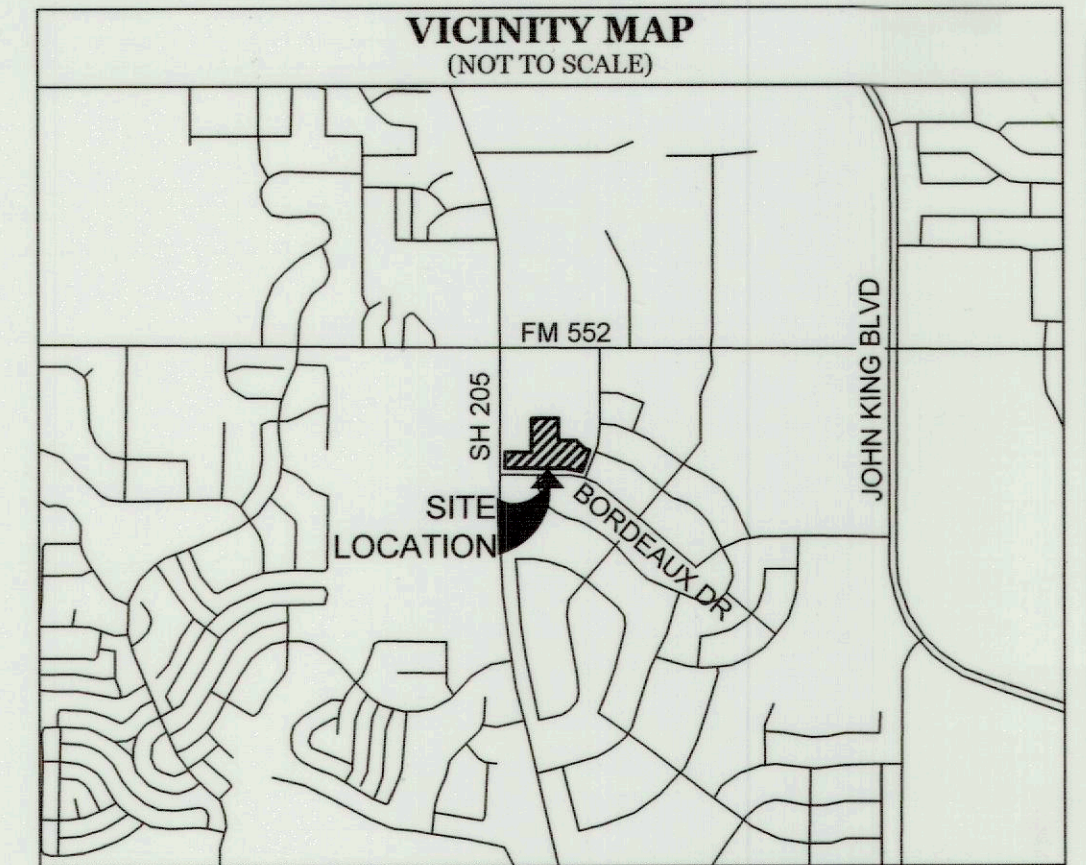
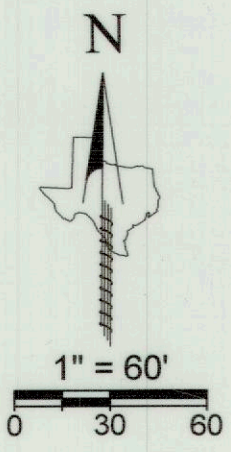

2024090315141 1:3 PLAT 08/29/2024 03:40:54 PM

LOT 1A, DIRKWOOD ESTATES  
OWNER: LIU JOHN Q AND CONNIE Q

LOT 1, BLOCK A, MASON-STEED ADDITION,  
OWNER: JOHN AND CONNIE Q LIU

LINE TABLE		
LINE	BEARING	DISTANCE
L1	N 19°02'20" W	74.57'
L2	S 01°27'38" E	12.00'
L3	S 30°00'00" E	74.41'
L4	S 69°46'45" E	40.60'
L5	S 62°21'14" W	44.50'
L6	N 00°49'54" W	68.64'
L7	N 19°02'20" W	49.57'
L8	S 58°48'44" W	9.98'
L9	N 31°11'16" W	20.00'
L10	N 58°48'44" E	14.28'
L11	S 89°45'14" W	4.09'
L12	S 43°12'02" W	48.68'
L13	S 45°55'00" E	11.85'
L14	N 89°09'25" E	14.52'
L15	S 00°56'57" E	15.00'
L16	S 88°57'16" W	20.68'
L17	N 45°55'00" W	33.16'
L18	S 87°56'13" W	39.76'
L19	S 00°55'00" E	1.50'
L20	S 89°05'00" W	149.00'
L21	N 00°55'00" W	2.50'
L22	S 89°05'00" W	5.84'
L23	S 59°05'00" W	43.04'
L24	N 59°05'00" E	32.90'
L25	N 89°05'00" E	14.63'
L26	N 00°55'00" W	10.25'
L27	N 89°05'00" E	86.00'
L28	S 00°55'00" E	1.20'
L29	N 89°05'00" E	115.06'
L30	S 00°55'05" E	57.32'
L31	N 89°05'00" E	179.06'
L32	S 89°05'00" W	178.89'
L33	N 00°55'00" W	58.36'
L34	N 44°05'00" E	42.48'
L35	N 77°14'52" E	16.45'
L36	West	490.93'
L37	N 00°49'55" W	10.00'
L38	East	485.30'
L39	S 02°57'53" W	5.06'
L40	S 00°32'04" W	9.61'

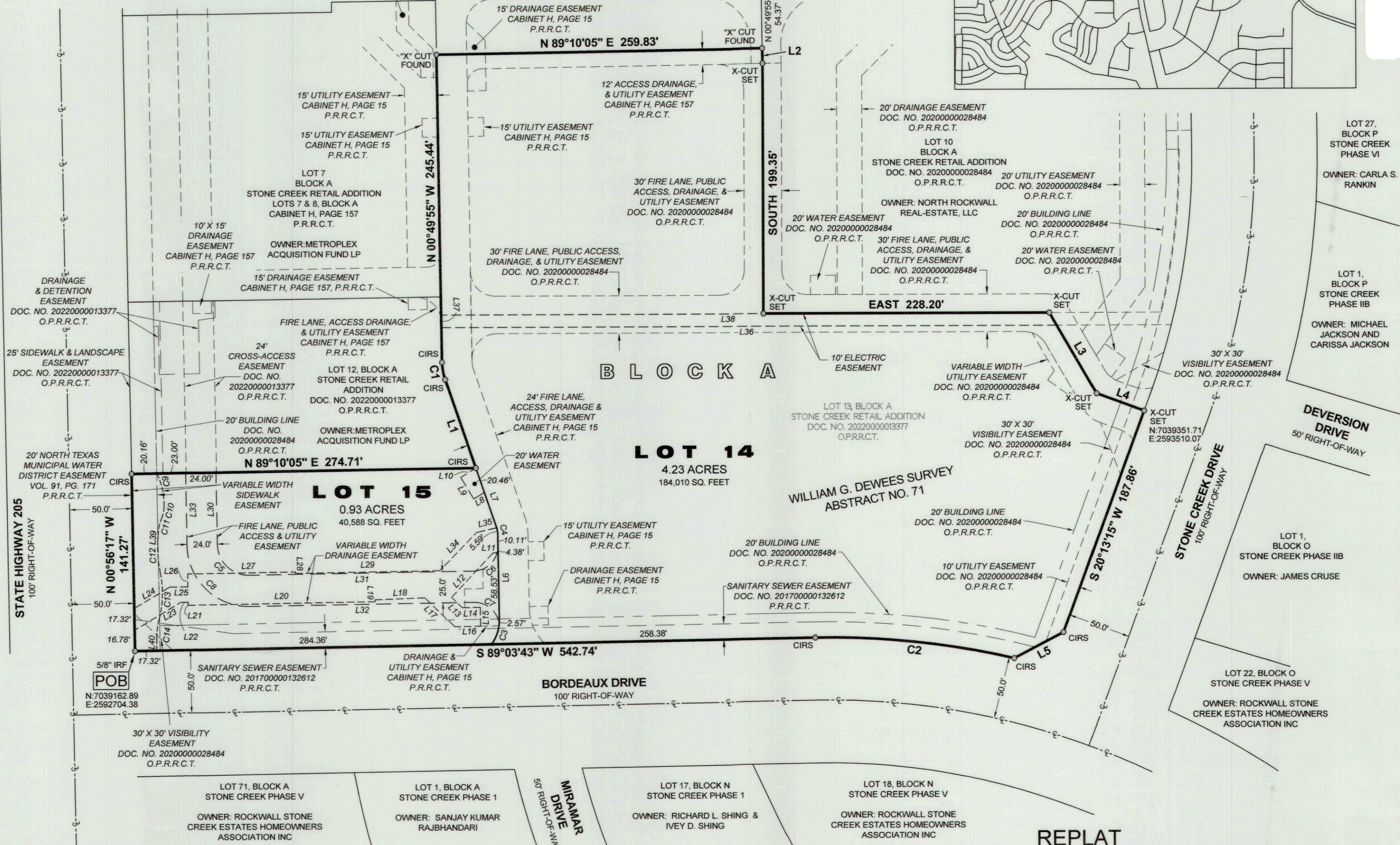

## REPLAT STONE CREEK RETAIL ADDITION LOTS 14 & 15, BLOCK A

BEING A REPLAT OF  
LOT 13, BLOCK A OF STONE CREEK RETAIL ADDITION  
BEING TWO (2) LOTS  
5.16 ACRES OR 224,598 SF  
SITUATED IN THE  
WILLIAM G. DEWEES SURVEY, ABSTRACT No. 71,  
CITY OF ROCKWALL, ROCKWALL COUNTY, TEXAS

~CASE NO.  
P2024-023  
PAGE 1 OF 3

Project  
1910.030-24

Date  
07/09/2024

Drafter  
TAR

**EAGLE SURVEYING, LLC**  
222 S. Elm Street, Suite 200  
Denton, TX 76201  
(940) 222-3009  
TX Firm #10194177

LEGEND	
POB	POINT OF BEGINNING
IRF	= IRON ROD FOUND
CIRS	= CAPPED IRON ROD SET
CIRF	= CAPPED IRON ROD FOUND
DOC. NO.	= DOCUMENT NUMBER
D.R.R.C.T.	= DEED RECORDS, ROCKWALL COUNTY, TEXAS
P.R.R.C.T.	= PLAT RECORDS, ROCKWALL COUNTY, TEXAS

**ENGINEER**  
ClayMoore Engineering  
1903 Central Drive, Suite 406  
Bedford, TX 76021  
(817) 281-0572

**SURVEYOR**  
Eagle Surveying, LLC  
222 S. Elm Street, Suite 200  
Denton, TX 76201  
(940) 222-3009

**OWNER**  
Metroplex Acquisition Fund, L.P.  
1717 Woodstead Court, Suite 207  
The Woodlands, TX 77380  
(855) 408-3390

LOT 71, BLOCK A STONE CREEK PHASE V  
OWNER: ROCKWALL STONE CREEK ESTATES HOMEOWNERS ASSOCIATION INC

LOT 1, BLOCK A STONE CREEK PHASE 1  
OWNER: SANJAY KUMAR RAJBHANDARI

LOT 17, BLOCK N STONE CREEK PHASE 1  
OWNER: RICHARD L. SHING & IVEY D. SHING

LOT 18, BLOCK N STONE CREEK PHASE V  
OWNER: ROCKWALL STONE CREEK ESTATES HOMEOWNERS ASSOCIATION INC



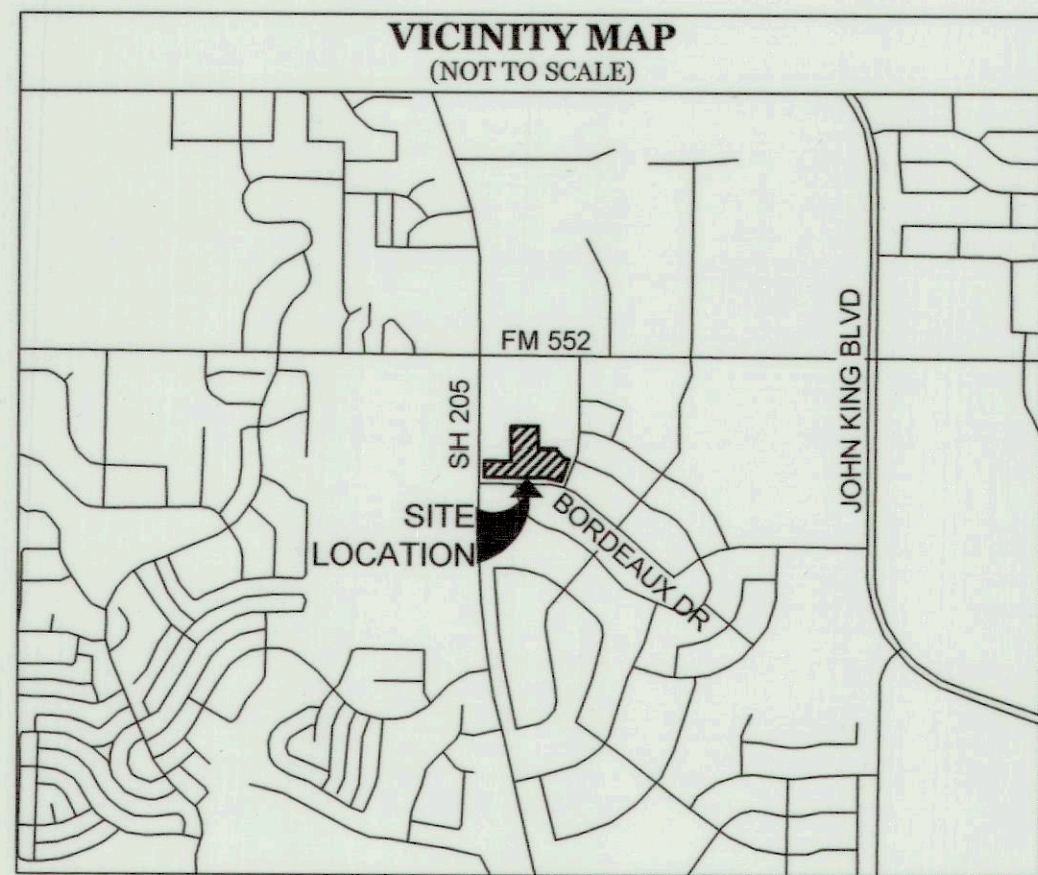

**GENERAL NOTES**

- 1.) The purpose of this plat is to subdivide a single lot of record creating two (2) lots and dedicating easements for site development.
- 2.) This property is located in "Non-shaded Zone X" according to the F.E.M.A. Flood Insurance Rate Map dated September 26, 2008 as shown on Map Number 48397C0030L.
- 3.) The grid coordinates shown on this plat are based on GPS observations utilizing the AllTerra RTKNET Cooperative network, North American Datum of 1983 (adjustment realization 2011) State Plane Coordinate System (Texas North Central Zone - 4202).
- 4.) Selling a portion of this addition by metes and bounds is unlawful and a violation of the Subdivision Ordinance of the City of Rockwall and Chapter 212, Municipal Regulation of Subdivisions and Property Development, of the Texas Local Government Code, and shall be subject to the City of Rockwall withholding utilities and building permits.
- 5.) All interior property corners are marked with a 1/2-inch iron rod with a green plastic cap stamped "EAGLE SURVEYING" unless noted otherwise.
- 6.) The bearings shown on this plat are based on GPS observations utilizing the AllTerra RTKNET Cooperative network, North American Datum of 1983 (adjustment realization 2011).
- 7.) The property owner shall be responsible for maintaining, repairing, and replacing and shall bear sole liability of all systems within the drainage and detention easements.
- 8.) It shall be the policy of the City of Rockwall to withhold issuing buildings permits until all streets, water, sewer and storm drainage systems have been accepted by the City. The approval of a subdivision plat by the City of Rockwall does not constitute any representation, assurance or guarantee that any building within such subdivision plat shall be approved, authorized, or permit issued, nor shall such approval constitute any representation, assurance or guarantee by the City of Rockwall of the adequacy and availability for water and sanitary sewer for personal use and fire protection within such subdivision plat, as required under the Subdivision Ordinance of the City of Rockwall.
- 9.) All decorative sign and light poles to be maintained, repaired, and replaced by property owner.
- 10.) All Fire Lanes will be constructed, maintained, repaired and replaced by the property owner. Fire Lanes shall be constructed in accordance with the approved Civil Engineering Plans for both on-site and off-site Fire Lane improvements

**NTMWD NOTES**

- A. NORTH TEXAS MUNICIPAL WATER DISTRICT (NTMWD) 20-INCH WATER PIPELINE IS LOCATED WITHIN THE LIMITS OF CONSTRUCTION.
- B. OPERATION OF HEAVY EARTHMOVING EQUIPMENT, COMPACTION EQUIPMENT OR HEAVY CONSTRUCTION EQUIPMENT, SUCH AS CONCRETE TRUCKS, SHALL BE RESTRICTED TO SPECIFIC CROSSING POINTS ACROSS NTMWD EASEMENTS, AS APPROVED BY THE NTMWD. THE CROSSINGS SHALL BE DESIGNATED AND VERIFIED TO PROVIDE A MINIMUM OF FIVE FEET OF COVER.
- C. TO ASSURE THE PLACING OF SIGNIFICANT LOADS OVER THE NTMWD PIPELINE DOES NOT DAMAGE THE EXISTING PIPELINE, NO MATERIALS SHALL BE STOCKPILED ON THE NTMWD EASEMENT WITHOUT AUTHORIZATION FROM THE NTMWD. IF THE CONTRACTOR DESIRES TO USE NTMWD'S EASEMENT FOR STOCKPILE OF MATERIALS, CONTACT NTMWD ENGINEERING AT (972) 442-5405 SO YOUR PLANS FOR USE OF NTMWD'S EASEMENT CAN BE REVIEWED.
- D. A MINIMUM OF 4.5 FEET SEPARATION BETWEEN BOTTOM OF PAVEMENT AND TOP OF NTMWD PIPELINE IS REQUIRED. IN ADDITION, IF SEPARATION BETWEEN THE BOTTOM OF PAVEMENT AND TOP OF PIPELINE IS LESS THAN 4.5 FEET, LIME STABILIZED IS NOT PERMITTED AND A THICKENED PAVEMENT SECTION IS REQUIRED.
- E. CROSSING OF THE NTMWD EASEMENT WITH OTHER UTILITIES, SUCH AS TV CABLE, PHONE, GAS AND ELECTRIC, SHALL BE COORDINATED WITH THE NTMWD TO AVOID DAMAGE TO THE NTMWD FACILITIES.
- F. OUTDOOR LIGHTING, LANDSCAPING, SCREENING WALLS OR OTHER FACILITIES SHALL NOT BE INSTALLED IN NTMWD EASEMENTS WITHOUT WRITTEN APPROVAL OF THE NTMWD.
- G. UNLESS OTHERWISE SHOWN OR REQUIRED, A MINIMUM OF TWO-FOOT CLEARANCE SHALL BE PROVIDED FOR ALL UTILITIES CROSSING THE NTMWD PIPELINES. DIRECTIONAL BORE CROSSINGS REQUIRE A MINIMUM OF FOUR-FOOT CLEARANCE.
- H. BORE CROSSINGS SHALL ONLY BE PERFORMED BETWEEN 9:00 AM AND 4:00 PM TUESDAY THRU THURSDAY.
- I. NO TREES ARE ALLOWED WITHIN THE NTMWD EASEMENT, ONLY CREPE MYRTLES, SHRUBS, AND BUSHES.
- J. A NTMWD REPRESENTATIVE IS REQUIRED TO BE ON-SITE FOR ANY WORK IN THE VICINITY OF NTMWD PIPELINES, FEATURES, OR FACILITIES.
- K. THE CONTRACTOR SHALL CONTACT NTMWD LINE LOCATES AT (469) 626 - 4569 AT LEAST 48 HOURS PRIOR TO PERFORMING ANY WORK IN THE VICINITY OF THE NTMWD PIPELINES, FEATURES, OR FACILITIES.
- L. FOR CROSSING UNDER NTMWD PIPELINES BY OPEN CUT, SHORING IS TO BE USED TO MINIMIZE EXPOSING THE NTMWD LINE. TRENCH WILL BE LIMITED TO FOUR FEET WIDE MAXIMUM.

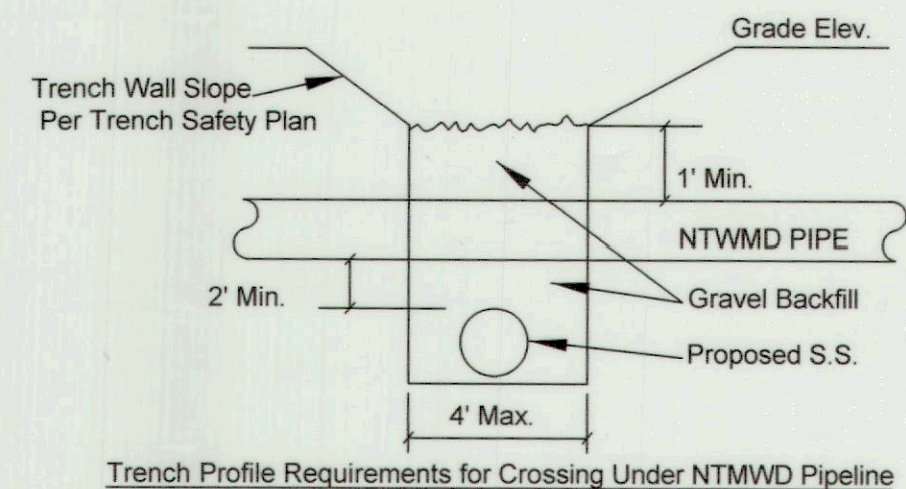

**REPLAT  
STONE CREEK RETAIL ADDITION  
LOTS 14 & 15, BLOCK A**

BEING A REPLAT OF  
LOT 13, BLOCK A OF STONE CREEK RETAIL ADDITION  
BEING TWO (2) LOTS  
5.16 ACRES OR 224,598 SF  
SITUATED IN THE  
WILLIAM G. DEWEES SURVEY, ABSTRACT No. 71,  
CITY OF ROCKWALL, ROCKWALL COUNTY, TEXAS

CASE NO.  
P2024-023  
PAGE 2 OF 3

Project	1910.030-24		<b>EAGLE SURVEYING, LLC</b>
Date	07/09/2024		222 S. Elm Street, Suite 200
Drafter	TAR		Denton, TX 76201 (940) 222-3009 TX Firm #10194177

**SURVEYOR**  
Eagle Surveying, LLC  
222 S. Elm Street, Suite 200  
Denton, TX 76201  
(940) 222-3009

**ENGINEER**  
ClayMoore Engineering  
1903 Central Drive, Suite 406  
Bedford, TX 76021  
(817) 281-0572

**OWNER**  
Metroplex Acquisition Fund, L.P.  
1717 Woodstead Court, Suite 207  
The Woodlands, TX 77380  
(855) 408-3390



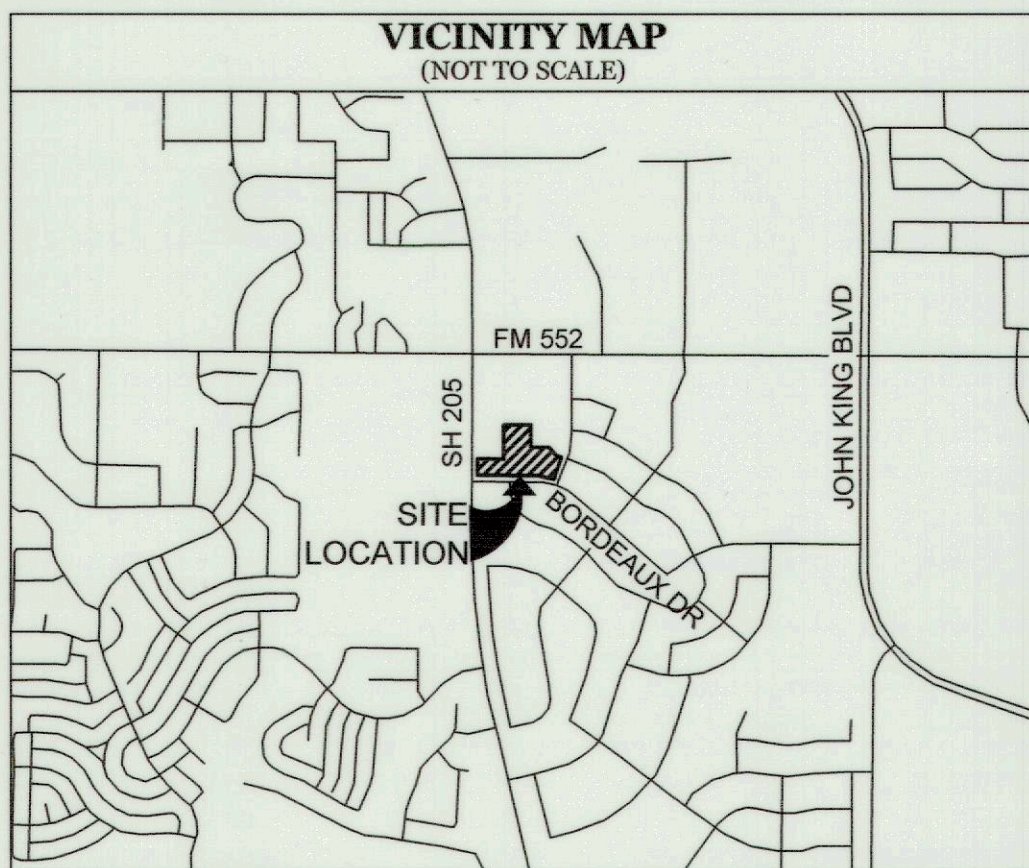

**OWNER'S CERTIFICATE & DEDICATION**

STATE OF TEXAS §  
 COUNTY OF ROCKWALL §

WHEREAS, METROPLEX ACQUISITION FUND, L.P., is the owner of 5.16 acres of land out of the William G. Dewees Survey, Abstract Number 71, situated in the City of Rockwall, Rockwall County, Texas, being all of Lot 13, Block A of Stone Creek Retail Addition, a subdivision of record in Document Number 20220000013377 of the Official Public Records of Rockwall County, Texas, said Lot 13 being a portion of a called Tract I - 21.1522 acre tract of land conveyed by Special Warranty Deed of record in Document Number 20080000409649 of said Official Public Records and being more particularly described by metes and bounds, as follows:

**BEGINNING**, at a 5/8" iron rod found at the intersection of the East right-of-way line of State Highway 205 (100' right-of-way) and the North right-of-way line of Bordeaux Drive (a 100' right-of-way), also being the Southwest corner of said Lot 13;

**THENCE**, N00°56'17"W, along the East right-of-way line of State Highway 205, being the common West line of said Lot 13, a distance of 141.27 feet to a 1/2" iron rod with green plastic cap stamped "EAGLE SURVEYING" set at the Southwest corner of Lot 12, Block A of said Stone Creek Retail Addition, also being the Northwest corner of said Lot 13;

**THENCE**, N89°10'05"E, leaving the East right-of-way line of State Highway 205, along the South line of said Lot 12, being the irregular North line of said Lot 13, a distance of 274.71 feet to a 1/2" iron rod with green plastic cap stamped "EAGLE SURVEYING" set at the Southeast corner of said Lot 12;

**THENCE**, continuing along the irregular North line of said Lot 13, being in part, the common East line of said Lot 12 and in part, the common East line of Lot 7, Block A of Stone Creek Retail Addition, Lots 7 & 8, Block A, a subdivision of record in Cabinet H, Page 157 of the Plat Records of Rockwall County, Texas, the following three (3) courses and distances:

1. N19°02'20"W, a distance of 74.57 feet to a 1/2" iron rod with green plastic cap stamped "EAGLE SURVEYING" set at the point of curvature of a tangent curve to the right;
2. Along said tangent curve to the right, having a radius of 44.00 feet, a chord bearing of N09°56'08"W, a chord length of 13.92 feet, a delta angle of 18°12'25", an arc length of 13.98 feet to a 1/2" iron rod with green plastic cap stamped "EAGLE SURVEYING" set at the point of tangency of said curve;
3. N00°49'55"W, a distance of 245.44 feet to an X cut found in the South line of Lot 2, Block A of Stone Creek Retail Addition, a subdivision of record in Cabinet H, Page 15 of said Plat Records;

**THENCE**, N89°10'05"E, along the South line of said Lot 2, being the common irregular North line of said Lot 13, a distance of 259.83 feet to an X cut found in the West line of Lot 10, Block A of Stone Creek Retail Addition, a subdivision of record in Document Number 20200000028484 of said Official Public Records;

**THENCE**, along the West and South lines of said Lot 10, being the common irregular North line of said Lot 13, the following five (5) courses and distances:

1. S01°27'38"E, a distance of 12.00 feet to an X cut set;
2. SOUTH, a distance of 199.35 feet to an X cut set at the Southwest corner of said Lot 10;
3. EAST, a distance of 228.20 feet to an X cut set;
4. S30°00'00"E, a distance of 74.41 feet to an X cut set;
5. S69°46'45"E, a distance of 40.60 feet to an X cut set in the West right-of-way line of Stone Creek Drive (100' right-of-way), being the Southeast corner of said Lot 10, also being the most Easterly Northeast corner of said Lot 13;

**THENCE**, S20°13'15"W, along the West right-of-way line of Stone Creek Drive, being the common East line of said Lot 13, a distance of 187.86 feet to a 1/2" iron rod with green plastic cap stamped "EAGLE SURVEYING" set at the North end of a cutback line at the intersection of the West right-of-way line of Stone Creek Drive and the North right-of-way line of Bordeaux Drive;

**THENCE**, S62°21'14"W, along said cutback line, a distance of 44.50 feet to a 1/2" iron rod with green plastic cap stamped "EAGLE SURVEYING" set in the curving North right-of-way line of Bordeaux Drive;

**THENCE**, along the North right-of-way line of Bordeaux Drive, being the common South line of said Lot 13, the following two (2) course and distances:

1. Along a non-tangent curve to the left having a radius of 650.00 feet, a chord bearing of N83°53'12"W, a chord length of 159.58 feet, a delta angle of 14°06'07", an arc length of 159.98 feet to a 1/2" iron rod with green plastic cap stamped "EAGLE SURVEYING" set at the point of tangency of said curve;
2. S89°03'43"W, a distance of 542.74 feet to the **POINT OF BEGINNING** and containing an area of 5.16 Acres, or (224,598 Square Feet) of land, more or less.

NOW THEREFORE KNOW ALL MEN BY THESE PRESENTS:

STATE OF TEXAS §  
 COUNTY OF ROCKWALL §

I (we) the undersigned owner(s) of the land shown on this plat, and designated herein as the **STONE CREEK RETAIL ADDITION, LOTS 14 & 15, BLOCK A** subdivision to the City of Rockwall, Texas, and whose name is subscribed hereto, hereby dedicate to the use of the public forever all streets, alleys, parks, water courses, drains, easements and public places thereon shown on the purpose and consideration therein expressed. I (we) further certify that all other parties who have a mortgage or lien interest in the **STONE CREEK RETAIL ADDITION, LOTS 14 & 15, BLOCK A** subdivision have been notified and signed this plat. I (we) understand and do hereby reserve the easement strips shown on this plat for the purposes stated and for the mutual use and accommodation of all utilities desiring to use or using same. I (we) also understand the following:

1. No buildings shall be constructed or placed upon, over, or across the off-site and on-site utility easements as described herein.
2. Any public utility shall have the right to remove and keep removed all or part of any buildings, fences, trees, shrubs, or other growths or improvements which in any way endanger or interfere with construction, maintenance or efficiency of their respective system on any of these easement strips; and any public utility shall at all times have the right of ingress or egress to, from and upon the said easement strips for purpose of construction, reconstruction, inspecting, patrolling, maintaining, and adding to or removing all or part of their respective system without the necessity of, at any time, procuring the permission of anyone.
3. The City of Rockwall will not be responsible for any claims of any nature resulting from or occasioned by the establishment of grade of streets in the subdivision.
4. The developer/property owner and subdivision engineer shall bear total responsibility for storm drain improvements.
5. The developer/property owner shall be responsible for the necessary facilities to provide drainage patterns and drainage controls such that properties within the drainage area are not adversely affected by storm drainage from the development.
6. No house dwelling unit, or other structure shall be constructed on any lot in this addition by the owner or any other person until the developer and/or owner has complied with all requirements of the Subdivision Regulations of the City of Rockwall regarding improvements with respect to the entire block on the street or streets on which property abuts, including the actual installation of streets with the required base and paving, curb and gutter, water and sewer, drainage structures, storm structures, storm sewers, and alleys, all according to the specifications of the City of Rockwall; or

Until an escrow deposit, sufficient to pay for the cost of such improvements, as determined by the city's engineer and/or city administrator, computed on a private commercial rate basis, has been made with the city secretary, accompanied by an agreement signed by the developer and/or owner, authorizing the city to make such improvements at prevailing private commercial rates, or have the same made by a contractor and pay for the same out of the escrow deposit, should the developer and/or owner fail or refuse to install the required improvements within the time stated in such written agreement, but in no case shall the City be obligated to make such improvements itself. Such deposit may be used by the owner and/or developer as progress payments as the work progresses in making such improvements by making certified requisitions to the city secretary, supported by evidence of work done; or

Until the developer and/or owner files a corporate surety bond with the city secretary in a sum equal to the cost of such improvements for the designated area, guaranteeing the installation thereof within the time stated in the bond, which time shall be fixed by the city council of the City of Rockwall.

I (we) further acknowledge that the dedications and/or exaction's made herein are proportional to the impact of the Subdivision upon the public services required in order that the development will comport with the present and future growth needs of the City; I (we), my (our) successors and assigns hereby waive any claim, damage, or cause of action that I (we) may have as a result of the dedication of exactions made herein.

METROPLEX ACQUISITION FUND, L.P.

BY: Billy J. Brice, III 7/15/24  
 Date

STATE OF Texas §  
 COUNTY OF MONTGOMERY §

BEFORE ME, the undersigned authority, on this day personally appeared **Billy J. Brice, III**, known to me to be the person whose name is subscribed to the foregoing instrument, and acknowledged to me that he executed the same for the purposes and considerations therein expressed and in the capacity therein stated.

GIVEN UNDER MY HAND AND SEAL OF THE OFFICE this 15th day of July, 2024.

Janice Johns  
 Notary Public in and for the State of Texas

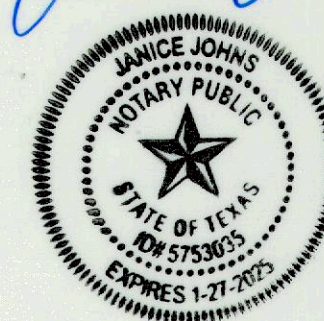

**CERTIFICATE OF SURVEYOR**

NOW THEREFORE KNOW ALL MEN BY THESE PRESENTS:

THAT I, **MATTHEW RAABE**, do hereby certify that I prepared this plat from an actual and accurate survey of the land, and that the corner monuments shown thereon were properly placed under my personal supervision.

Math Raabe 07-10-24  
 Registered Professional Land Surveyor

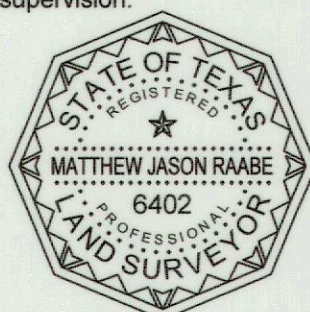

STATE OF TEXAS §  
 COUNTY OF DENTON §

BEFORE ME, the undersigned authority, on this day personally appeared **Matthew Raabe**, known to me to be the person whose name is subscribed to the foregoing instrument, and acknowledged to me that he executed the same for the purposes and considerations therein expressed and in the capacity therein stated.

GIVEN UNDER MY HAND AND SEAL OF THE OFFICE this 10th day of June, 2024.

Tyler McCaslin  
 Notary Public in and for the State of Texas

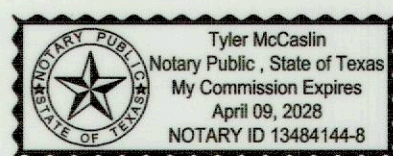

Filed and Recorded  
 Official Public Records  
 Jennifer Fogg, County Clerk  
 Rockwall County, Texas  
 08/29/2024 03:40:54 PM  
 \$147.00  
 2024000015141



Jennifer Fogg

Project	1910.030-24	<b>EAGLE SURVEYING, LLC</b> 222 S. Elm Street, Suite 200 Denton, TX 76201 (940) 222-3009 TX Firm #10194177
Date	07/09/2024	
Drafter	TAR	

**SURVEYOR**  
 Eagle Surveying, LLC  
 222 S. Elm Street, Suite 200  
 Denton, TX 76201  
 (940) 222-3009

**ENGINEER**  
 ClayMoore Engineering  
 1903 Central Drive, Suite 406  
 Bedford, TX 76021  
 (817) 281-0572

**OWNER**  
 Metroplex Acquisition Fund, L.P.  
 1717 Woodstead Court, Suite 207  
 The Woodlands, TX 77380  
 (855) 408-3390

**REPLAT**  
**STONE CREEK RETAIL ADDITION**  
**LOTS 14 & 15, BLOCK A**

BEING A REPLAT OF  
 LOT 13, BLOCK A OF STONE CREEK RETAIL ADDITION  
 BEING TWO (2) LOTS  
 5.16 ACRES OR 224,598 SF  
 SITUATED IN THE  
 WILLIAM G. DEWEES SURVEY, ABSTRACT No. 71,  
 CITY OF ROCKWALL, ROCKWALL COUNTY, TEXAS